

SU3000

Barrier Optical Turnstile

The Supervisor 3000 optical turnstile has a slim profile and stylish, architectural design that enhances any access control installation. The SU3000 has motorized barrier arms that quickly move down and into the cabinet to provide high throughput in both passage directions.



COMMON APPLICATIONS

- Employee and Visitor Access Control
- Time and Attendance Integration

TYPICAL INSTALLATION SITES

- Government Facilities
- Corporate Lobbies
- Health/Recreation Centers

FUNCTION

The Supervisor 3000 provides bi-directional access control and other operational and passage modes (described below). In controlled passage mode, upon receipt of a valid card signal from an access control system, the motorized barriers of the turnstile retract into the cabinet allowing a single user to pass through the turnstile in the requested direction. If an unauthorized user attempts to tailgate on the entry, the unit will recognize the illegal passage, a violation alarm will sound and red notification lights will flash.

The SU3000 utilizes tandem motorized barriers, distributed processing and integrated optical sensors to control access. The optical sensors detect patrons, determine the direction of patron movement and (in conjunction with the facility access system) detect unauthorized users. In addition to detecting "piggybacking" or "tailgating" on allowed entries, the SU3000's sensors prevent barriers from closing on users. If the barriers do encounter an obstruction on either opening or closing, the SU3000's software detects the obstruction and takes corrective action, precisely controlling the motors to minimize impact.

While access control throughput will depend on the access control system and readers used, the SU3000 supports extremely rapid throughput. It will "stack" valid scans and process patrons as fast as they can walk through the turnstile.

IP-based communication and configuration functionality is included in all SU3000 optical turnstiles, making it possible to adjust core turnstile settings via a TCP/IP network session using an included web application called LaneConfig. Using a PC, tablet or smart phone, this application allows adjustment of configurable features – such as alarm sounds, motor settings, optical settings, detection settings, tailgating, safety sensor settings, alarm timer settings, etc. – over a TCP/IP network. If the turnstiles are not networked, adjustable features are configured by loading LaneConfig on a laptop and plugging directly into an Ethernet port in the turnstile.

Alvarado also offers a web-based monitoring and scheduling application (optional) called GateKeeper. This application provides a virtual desktop of installed turnstiles, providing an attendant a convenient method to view and control day-to-day operational functions such as alarm notifications, implementing one-time passages, and changing turnstile operational modes.

GateKeeper also includes a scheduling function that allows a facility to automate changes in turnstile operational modes. This convenient functionality allows facilities to automatically implement desired turnstile operational changes at preset times such as at the beginning and end of shifts, lunch times, weekends, holidays, etc. GateKeeper provides a complete log of turnstile activity, for such items as activations, alarm conditions, and operational mode changes. Activities of attendants using GateKeeper are tracked as well.

More information about LaneConfig and GateKeeper is available in the Available Related Applications section of this document. Additional detailed information can also be obtained by contacting Alvarado technical support.



AVAILABLE CONFIGURATIONS

SU3000 / SU3000E

The SU3000 consists of a pair of end cabinets with barrier arms that create a single 28" (711 mm) wide passageway. The SU3000E is an extension center cabinet, with the same dimensions as an end cabinet, used to create additional turnstile passage lanes with the addition of a single cabinet. For example, one SU3000 and one SU3000E would be used to create two lanes. Additional extension center cabinets are used to create additional lanes; e.g., one SU3000 and two SU3000Es create three lanes. An unlimited number of center cabinets can be added.



28" passage width

SU3000-A / SU3000E-A

The SU3000-A consists of a pair of end cabinets with barrier arms that create a single 36" (914 mm) wide passageway. The SU3000E-A is an extension center cabinet with barrier arms on both sides of the cabinet, to allow an additional 36" passage lane to be created with the addition of a single cabinet as described in the section above. An unlimited number of center cabinets can be added.

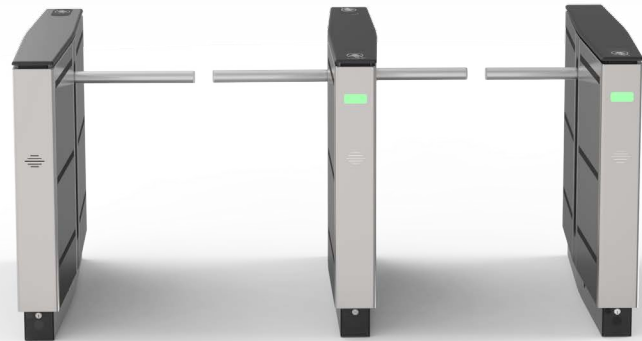

Multi-lane configuration with 36" passage width on left and 28" passage width on right

AVAILABLE FINISHES

STAINLESS STEEL, POWDER COATED AND PLATED

External cabinet materials are fabricated from #304 stainless steel polished to a #4 satin finish. Powder coated and plated cabinets are available (see Options).

MATERIALS

CABINET

Cabinets are fabricated from #304 stainless steel.

CABINET LIDS

Cabinet lids are fabricated from Livingstone solid surface acrylic (color: Starry Night Black). Lids can also be provided in any available solid surface color. Stainless steel inlay framed by solid surface is available (see Options).

INTERNAL FRAME

A powder coated steel internal frame houses electronics, sensors, motors and other internal components.

MOVING BARRIER ARMS

Barrier arms are fabricated from 1.75" (44 mm) diameter aluminum tubing with a clear anodized finish. Barrier arms come in widths to create 22" or 36" passage openings.

CONTROLS, OPERATIONAL MODES AND FUNCTIONALITY

CONTROL MECHANISMS

The precise movement of the SU3000's motorized barrier arms is accomplished through brushless DC motors working in conjunction with position encoders and motor controllers. A main turnstile controller runs the operational application and interfaces to the motor controllers and optics over an internal high speed serial network. The turnstile controller also interfaces to outside configuration and administrative applications, LaneConfig and/or GateKeeper, via TCP/IP – see Available Related Applications.

PASSAGE MODES

The SU3000 offers the following user-configurable passage modes:

Controlled Passage	Note: Controlled Passage is provided in three operating modes: normally closed; normally open; or barrier disabled (see below). Normally closed operating mode is described here. The arms are up, securing the turnstile. Upon receipt of an authorization signal from an access control system the arms move down to the open position, allowing a single passage in the authorized direction. The arms return to the closed position after the user has passed through the turnstile or the time frame allowed for entry has expired. Controlled Passage mode can be implemented either in a single direction or bi-directionally.
Free Passage	Authorization signal is not required for a user to pass through the lane. Free passage works in both Normally Closed mode (arms up until pedestrian enters the lane) or Normally Open mode (arms remain down at all times). Free Passage mode can be implemented either in a single direction or bi-directionally.
No Passage (Direction closed)	No passage is allowed. The arms are up, securing the turnstile. Valid electronic credentials are ignored and passage is not allowed. The barrier will still open if a fire alarm or life safety input is received. No Passage mode can be implemented either in a single direction or bi-directionally.
Visitor	Allows visitors and groups without credentials access through the turnstile. When placed in visitor mode, the barriers open and remain open. Passages in either direction are monitored and an I/O output is provided for each passage.



OPERATING MODES

The SU3000 offers the following user-configurable passage modes:

Normally Closed	See Controlled Passage mode description above.
Normally Open	The arms are down, providing a barrier-free passageway. The arms will not raise and secure the turnstile unless tailgating or unauthorized passage is attempted. Normally Open mode should be used only in select applications. Contact Alvarado for recommendations.
Barrier Disabled	The arms remain down at all times allowing the SU3000 to function as an optical (barrier-free) access control turnstile.



USER STATUS DISPLAY

An illuminated status icon display that is visible to users is flush mounted within the cabinet lid and is configured to function in the following manner:

Yellow Card Icon	An illuminated yellow card means the turnstile is ready for card presentation.	
Green Arrow Icon	An illuminated green arrow indicates passage is allowed in the direction of the arrow and/or valid credentials have been presented. A flashing green arrow indicates the turnstile is in Free Passage mode in the direction of the arrow.	
Red Stop Icon	An illuminated red X indicates passage is prohibited in the direction of the arrow. A flashing red X indicates the turnstile has an alarm condition and/or invalid credentials have been presented.	

OPEN / CLOSE STATUS LIGHTS

An opaque end piece is mounted to the upper end “leg” on each side of the turnstile diffusing green and red signal lights. The lights function similar to toll booth lights, and perform in the following manner:

Green	An illuminated green bar indicates the turnstile is open for use. The bar remains green when a valid card input is received.	
Red	An illuminated red bar indicates the turnstile is closed for use. The barrier will not open in the direction of travel unless the direction is “exit” and a fire alarm or life safety input is received.	
Red Flashing	A flashing red bar indicates the turnstile has an alarm condition. The duration of the alarm condition and flashing is user definable for select alarms through LaneConfig software.	

FUNCTIONALITY - USER CUSTOMIZABLE FEATURES AND AVAILABLE TOOLS

In addition to the available passage and operating modes, the SU3000 has a number of additional user customizable features. These features allow turnstiles to be “tuned” to the operational requirements of an application and allow users to associate individual audio sounds with operational states and alarm conditions. SU3000 turnstiles also come with tools to assist service personnel with setup, diagnostics and troubleshooting.



Customizable features and custom sounds are downloaded to turnstiles over a TCP/IP network using the included LaneConfig application. Users may create and install their own audio sounds in the form of .wav files.

Prior to shipping, turnstiles are configured with settings and default sounds that are appropriate for most facilities. A summary of configurable features and setup/diagnostic tools is listed below.

Operational Adjustments	Description
Barrier Breakaway	Controls barrier breakaway force if manually forced
Barrier Impact	Controls barrier operation if moving barriers encounter an object during operational cycle
Access Timeout	Valid credential presented but user does not pass through turnstile; controls time before barriers close and turnstile resets
Object	Controls object detection size
Tailgating	Controls tailgating sensitivity
Unauthorized Entry	Controls number of entry sensors a user can block before triggering alarm
Blocked Sensor	Controls time before alarm is generated if sensors are blocked

Operational Sounds / Alarms	Description	Configurable Sounds
Access Granted*	Good card	√
Access Denied*	Bad card	√
Unauthorized Presence*	User enters turnstile without presenting card	√
Tailgating/Unauthorized Passage*	Tailgating/unauthorized passage detected	√
Blocked Sensor	Sensors not cleared	√
Unsafe to Open/Close*	Barriers are not opening/closing due to unsafe condition	√
Barrier Breakaway	Barriers have been forced open	√
Barrier Impact	Barriers encounter an object when moving	√
Crawl Sensor	Object detected by a crawl sensor	√

*Configurable for both entry and exit direction

Setup / Diagnostic Tools	Description	Configurable Sounds
Barrier Position (Home)	Barrier home position setting	N/A
Barrier Position (Open)	Barrier opening position setting	N/A
Startup	Appropriate startup engaged	√
Barrier Lingers	Barriers have stayed open past the allotted time to close	√
Debug	General debug application for troubleshooting	N/A
Optic Debug	Debug application for optics	N/A
Motor I/O Debug	Debug application for motor communication	N/A
Emergency Override Direction	Allows installer to set emergency override direction	N/A



ALARM CONDITIONS

In the event of an alarm condition, the designated alarm sound is played (see chart on previous page) and both the status icon display and open/closed status lights will illuminate red. An I/O output is also provided for most alarm conditions - see Turnstile Interface to Access Control System section.

BARRIER BREAKAWAY

All SU3000 turnstiles utilize motor force and an electromechanical brake to provide adjustable resistance against a user pushing the barrier arms open. The force it takes to push the arms open is an adjustable setting, up to the product maximum. Approximate maximum holding force measurements are available from Alvarado. When the set or maximum holding force is reached, the arms "break away" and retract into the cabinet. The arms automatically reset to the home (closed) position.

BARRIER CYCLE TIME

This is an adjustable feature. Factory set opening, and recommended, speed is approximately 500ms.

BARRIER IMPACT

In the event that the barrier arms encounter resistance while opening or closing, the arms will stop moving, an alarm will sound and the status icon display and open/closed status lights will illuminate red to indicate an alarm condition. The arms will automatically reset once the obstruction is cleared from the lane. The barrier impact setting is adjustable.

EMERGENCY OVERRIDE / FIRE ALARM

Activation to open the arms in conjunction with a fire alarm or other life safety system is achieved by supplying a sustained dry contact to the SU3000. During emergencies the SU3000 arms will open in the exit direction and remain open. Status lights and alarm notifications will turn off.

POWER FAILURE

In the event of a loss of power to the unit, the arms of the SU3000 can be freely moved. When pushed the arms will remain down leaving a clear passageway.

CARD READERS

SPACE FOR INTERNAL INSTALLATION OF CARD READERS

Internal space is available for mounting of slim style proximity card readers. The internal space available is 1.0" H x 1.9" W x 6.5" D (25 mm x 48 mm x 165 mm). Use of larger readers is accomplished through custom solutions (see Options).



TURNSTILE INTERFACE TO ACCESS CONTROL SYSTEM

There are two types of interfaces to allow an access control system to operate with the SU3000:

Dry Contact

Single passage activation, and other functionality, is achieved by supplying an isolated, voltage free, momentary dry contact at the appropriate location on the I/O control board. Various outputs are also available to provide information on turnstile operational status and activity. A description of available input and output signals is provided below.

Input Signal	Entry / Exit
Direction Closed	√
Good Card (Activation)	√
Bad Card	√
Passage - Free Pass Mode	√
Single Entry Override	√
Life Safety Input	√

Output Signal	Entry / Exit
Authorized Passage	√
Unauthorized Passage	√
Unauthorized Presence	√
Sensor Blocked	√
Lingering Barrier	√
Crawl Detection	√

TCP/IP

A TCP/IP interface is also available. This method allows a third party access system to control turnstile operation similar to the dry contact method, through the use of TCP/IP commands and responses. There is an additional charge for this interface method and implementation requires a one-time programming effort on the part of the access system provider. Contact Alvarado for pre-evaluation of project requirements.

AVAILABLE RELATED APPLICATIONS

There are two additional applications that are available with the SU3000.

LANECONFIG

LaneConfig is a web-based application that comes standard with all SU3000's. The application allows configurable features of the SU3000 and software updates to be installed over a network. Use of LaneConfig in a networked setting eliminates the need to physically plug into individual turnstiles to change turnstile configurations or update software. LaneConfig is accessible from a PC, tablet or smart phone that is that is networked to installed SU3000 turnstiles.

In installations where SU3000 turnstiles are not networked, LaneConfig is loaded on a laptop which is temporarily plugged into the Ethernet port of individual turnstiles when turnstile configurations are changed or software is updated.

GATEKEEPER

GateKeeper is an optional web-based application that allows all Alvarado optical turnstiles installed at a site to be monitored and controlled from a single PC. GateKeeper allows control of virtually all day-to-day operating functions, including designating a turnstile as entry or exit, opening or closing a turnstile, and allowing single passage overrides for guests or personnel that have forgotten their access card. The application also includes various other functions. These include an emergency “open all turnstiles” capability that is in addition to the emergency override/fire alarm capabilities described earlier in this document. The application has tiered login levels with three levels of security (User, Supervisor and Administrator). The higher permission levels enable various additional features and settings.

GateKeeper has an intuitive graphic interface that gives desk attendants a current “status” of all installed turnstiles. In addition, when alarm conditions occur, the application provides both visual and audio notification of what happened. All actions (such as passage overrides) and turnstile alarms are logged. Logs may be printed or saved for recordkeeping or diagnostic purposes.

GateKeeper also includes a built in Event Scheduler. This extremely useful tool allows day-to-day operational changes that are often implemented at sites to be scheduled and automatically implemented without the need for a guard or attendant to “remember” to change settings. Event Scheduler allows operation templates to be saved and then automatically implemented at user defined times. Examples include changing the entry status of turnstiles (entry, exit, bi-directional control or free passage) at set times of the day. Similarly, a facility may want barriers activated or disabled at select times and/or only specific lanes operational on weekends and holidays. This flexibility allows turnstiles to be used more efficiently, can decrease the number of turnstiles that may be needed, and allows Alvarado’s optical turnstiles to seamlessly integrate into a customer’s operational requirements.

A single license of GateKeeper allows users to control all turnstiles installed at a single licensed site.

OPTIONS

ALTERNATE LID COLORS AND MATERIALS

Lids can be provided in any available solid surface color. Lids with a laser cut stainless steel inlay within a solid surface frame can be provided. Select alternate materials are also available.

ALTERNATE POWER SUPPLY

A 220-240 VAC, 50 Hz power supply and EU wiring scheme.

PLATFORM

A platform for either single turnstile or multi-turnstile configurations is available. The passageway area of the platform is powder coated with a highly-textured black coating. The platform includes enclosed cable runs and eliminates the need for trenching or stubbing up conduit from floor.

BREAKAWAY ARMS

The SU3000 arms can be broken away horizontally in the direction of travel. Arms automatically reset to the closed position.



CARD READERS / PHYSICAL ACCESS DEVICES

Due to the slim architectural profile of the SU3000, generally only mullion sized readers can be housed inside the cabinet. Custom fabricated solutions, including pedestals, are used to house alternative readers. When intending to use readers other than mullion size, provide the manufacturer name, model number and a physical sample of the reader to Alvarado.

CUSTOM CABINET FINISHES

External cabinet materials may be powder coated in a variety of colors. Cabinet materials can also be plated in a variety of finishes.

ELEVATOR DESTINATION DISPATCH

The SU3000 can integrate with virtually any Elevator Destination Dispatch solution to direct users to the correct elevator when presenting their authorized credentials. The dispatch display can be mounted directly to the turnstile, eliminating the need for employees/visitors to identify themselves a second time when entering an elevator.

LONGER INTERCONNECT BETWEEN CABINET CABLES

Longer interconnecting cables are available to accommodate installations where standard conduit runs are not available. The standard interconnect cable length is 8' (244 cm). Cables are also available in 20' (610 cm) or 40' (1220 cm) lengths.

MONITORING AND OPERATIONAL MODE SCHEDULING SOFTWARE

GateKeeper web-based communication and control software communicates with SU3000 turnstiles over a wired TCP/IP network. For more information, see the description provided earlier in this document or contact Alvarado for more information.

POWER SUPPLY - EXTERNAL ENCLOSURE

A portable enclosure is provided for remote installation of the Supervisor primary power supply. The enclosure houses up to three power supplies (one power supply is required per Supervisor turnstile). Conduit entry/exit ports are provided for connecting 110/220 VAC primary power to the power supplies and running 24 VDC power to the turnstiles. The low-voltage wire run should not exceed 100' using the specified wire gauge.

TURNSTILE KEY CONTROLS

There are two 3-position key switches installed on the turnstile to control passage modes for both directions of travel. Turning the key to one of three positions overrides current settings and places the turnstile in Controlled Passage, Free Passage or No Passage mode depending on orientation of the key.



CONDUIT REQUIREMENTS

PRIMARY POWER CONDUIT

.75" (19 mm) power conduit for primary power must be run to each main controller cabinet. Note: The product standard is 110-120 VAC (use of 220-240 VAC is an option).

LOW-VOLTAGE AND COMMUNICATION CONDUIT

1.5" (38 mm) conduit must be run to allow passage of the interconnect cable between cabinet sets. 8' (244 cm) interconnect cables are included. 20' (610 cm) and 40' (1220 cm) interconnect cables are available options.

ACCESS CONTROL SYSTEM AND READER CONDUIT

The SU3000 has space for the acceptance of a .75" (19 mm) conduit for access control and reader cabling. Alvarado does not provide cables for access control systems.

TCP/IP CONDUIT

Use of TCP/IP communication with LaneConfig or GateKeeper requires the running of an Ethernet cable to each main controller cabinet. Do not run cable in the same conduit as AC Power.

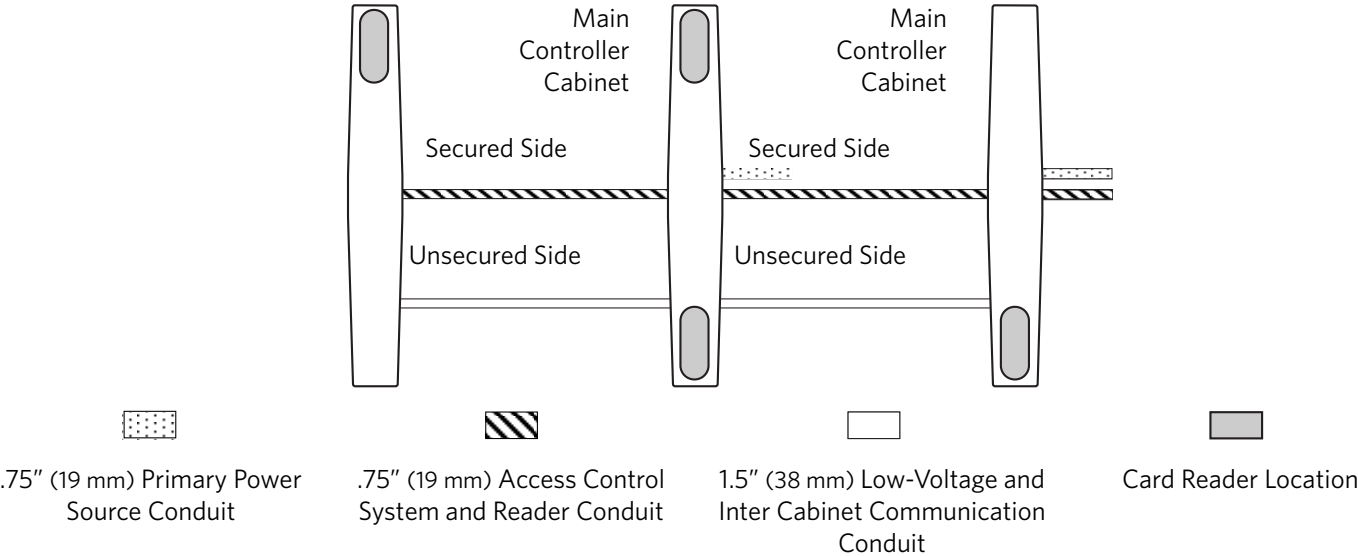

SHIPPING AND SITE PREPARATION

SHIPPING

SU3000 cabinets are shipped fully assembled for easy installation. Each cabinet includes mounting hardware (anchors, bolts, washers, etc.) to mount the unit to a standard, level concrete floor.

SITE PREPARATION

Turnstiles must be installed on a firm foundation in a manner that allows the required power and access control cabling to be pulled into the turnstile cabinet. The slab platform should be a minimum of 4" (102 mm) deep, level concrete. Installation should be performed by a skilled installer following Alvarado's instructions. Detailed drawings and installation manuals are available online.

TECHNICAL DIMENSIONS

Dimensions are shown in inches (mm). All measurements are approximate.

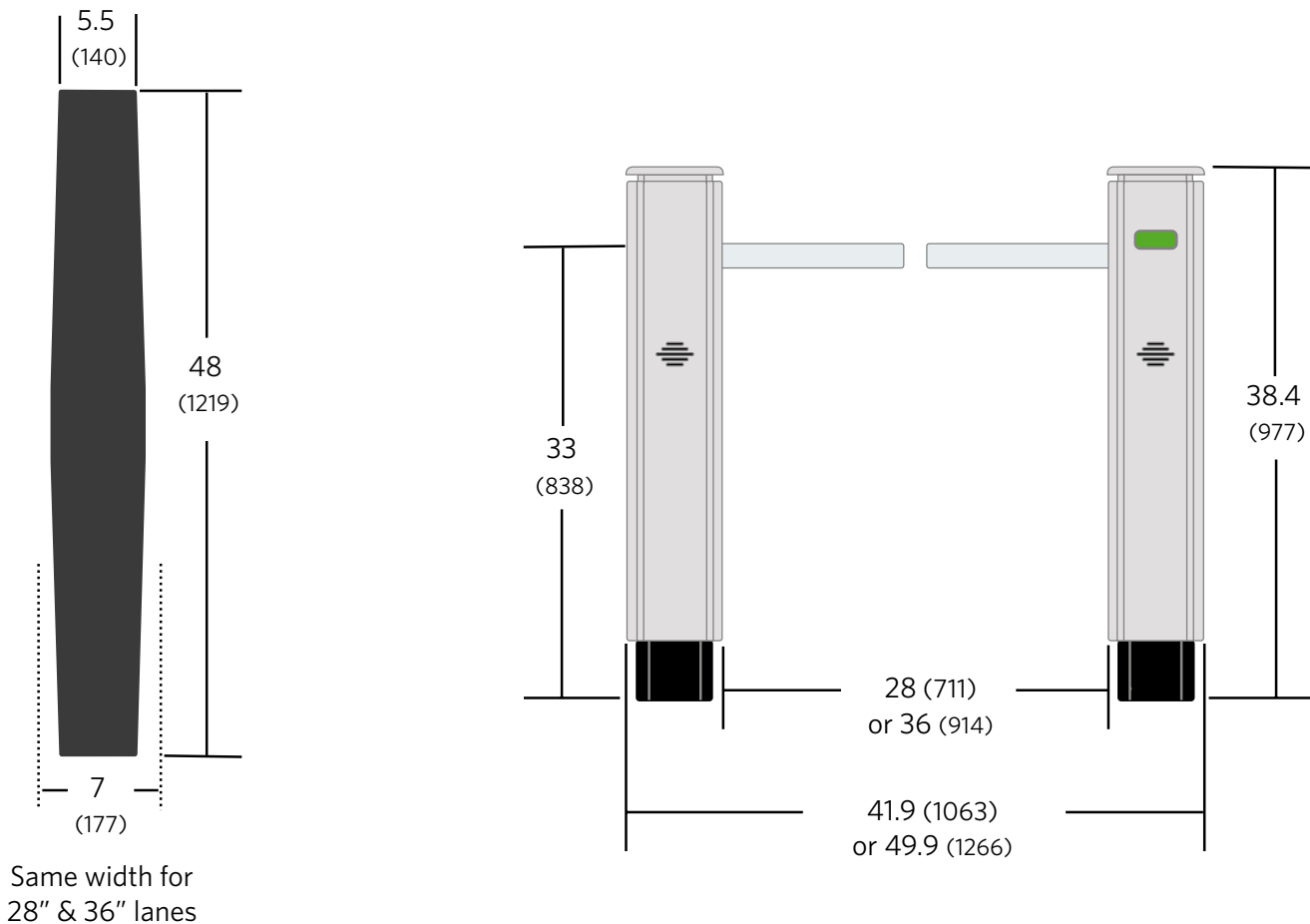

Descriptive Specification

SU3000 Barrier Optical Turnstile

Approximate Throughput Rates

Card Reader Type*	Users per minute
Proximity	40

*Access control system response is assumed to be instantaneous

Electrical	Description
UL Rated Power Supply	110-120 VAC, 60 Hz or 220-240 VAC, 50 Hz (optional)
Power Requirements	Maximum power consumption is 300W per lane with all options installed.
Operational Voltage	Primary power is stepped down and rectified for low voltage 24 VDC, 12 VDC, and 5 VDC operation.
On/Off Key Switch	An on/off key switch is located on each main cabinet.
Fuse Protection	A 2.5 amp fuse (slo-blo) is installed in each main cabinet.
Surge Protection	Alvarado suggests use of surge protection equipment in connection with the installation to protect electronics

Weights and Environmental

Product Weight	370 lbs.	168 kg Weight for a standard 28" lane (two cabinets)
Shipping Weight	660 lbs.	299 kg Includes weight of shipping crate(s)
Operating temperature	50° to 90° F	10 to 32° C
Storage Temperature	32° to 104° F	0 to 40° C
Relative Humidity	15-85% (non-condensing)	--

WARRANTY

For a period of 18 months from the date of purchase, Alvarado will replace or repair, at Alvarado’s option, any products or parts which are defective in materials or workmanship, provided recommended installation and maintenance procedures are followed. This warranty is void if damage is due to improper installation, maintenance or use. This warranty is limited to parts only, and does not cover labor or shipping charges incurred in connection with the removal or replacement of warranted products or parts.

This warranty is expressly made in lieu of any and all other warranties, expressed or implied, including, but not limited to implied warranties of merchantability and fitness for a particular purpose. Alvarado shall not be liable for any loss or damage, directly or indirectly, arising from the use of purchased products. In no event shall Alvarado be liable to buyer for consequential damages, special damages, incidental damages, loss of use, business interruption, loss of profits, or damages of any kind arising out of the use or inability to use a purchased product. In no event shall Alvarado be liable for damages which exceed the purchase price of a covered product.