



HI-PE Plus Metal Detector

Enhanced Walk-through Multi-zone
Metal Detector

KEY FEATURES

- Accurate Detection of all Metallic Threat Items
- High Discrimination and Throughput
- Exceptional Immunity to external interferences
- Compliant with and Certified to the Strictest Security Standards for weapons detection
- Unmatched Reliability
- Rapid Installation
- Panel Design



CERTIFIED BY GOVERNMENTAL LABORATORIES*

* Data available upon request

HI-PE PLUS MULTI-ZONE METAL DETECTOR

The **HI-PE Plus Multi-Zone Metal Detector** provides accurate detection of all metals, high level of discrimination of non-threat items, full compliance with the latest Security Standards and exceptional immunity to external interferences.



ACCURATE DETECTION OF ALL METALLIC THREAT ITEMS

- Capability to detect the full range of metal weapon threats even within body cavities
- 60 localization zones: • 20 vertical • 3 lateral
- Met-Identity technology for Identification of Threat Composition



The most advanced Security Standards require detection of all ferrous and non-ferrous metal weapons and of those constructed in special non-magnetic alloys. **The HI-PE Plus detects firearms and knives of this type, even when they are hidden within body cavities**, and accurately indicate the position of the threat, its intensity and its prevalent composition. Inspection personnel thereby acquire thorough knowledge of the metal item and can act, according to procedures, with maximum effectiveness and security.



MOST POWERFUL AND VERSATILE SECURITY FEATURES

- Up to 50 built-in Security Programs
- Up to 30 International Standards
- Up to 20 Customizable Levels

Setting the Security Levels could not be easier and more versatile than in the HI-PE Plus. Users can choose directly from the known International Standards or request implementation of a Standard personalized to their own requirements. Users can also create their own program and save it in internal memory for later use.

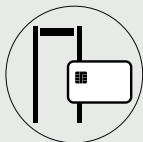

- Chip Card system for fast, simple and secure parameter changes (i.e. alarm volume and tone, counter reading, etc.) and security level selection
- Any security standard can be enhanced with selectable random alarm probability

60 LOCALIZATION ZONES



CHIP CARD SYSTEM

The system allows Security Management to set the Security Level quickly, reliably and without having to program the device in any way.



CEIA USA reserves the right to make changes, at any moment and without notice, to the models (including programming), their accessories and options, to the prices and conditions of sale.

HI-PE PLUS MULTI-ZONE METAL DETECTOR

The HI-PE Plus has a very low nuisance alarm rate even at the strictest Security Standards requested today, and therefore allows high transit flow rates and the minimum need for intervention by inspection personnel.



HIGH DISCRIMINATION AND THROUGHPUT

- Cutting-edge discrimination technology allows personal effects to be ignored, creating rapid transit flow
- No need to remove items such as belts, coins, keys, jewelry, watches, wallets, etc.
- Better Discrimination = Shorter Lines and Less Staffing

The HI-PE Plus has a **very low nuisance alarm rate even at the strictest Security Standards** requested today, and therefore allows high transit flow rates and the minimum need for intervention by inspection personnel.

ALARM



NO ALARM



MET-IDENTITY TECHNOLOGY

With Met-Identity technology, the HI-PE Plus allows you to know where, how much and what type of metal is being brought into the secure area.



EXCEPTIONAL IMMUNITY TO EXTERNAL INTERFERENCES

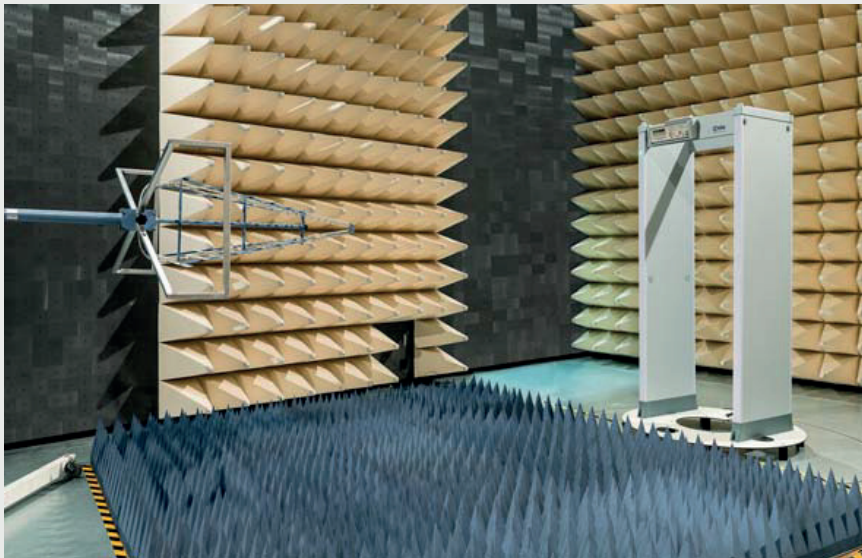

Exceptional immunity to environmental interferences makes the **Metal Detector easy to use even when electrical noise is encountered.**

CEIA USA reserves the right to make changes, at any moment and without notice, to the models (including programming), their accessories and options, to the prices and conditions of sale.

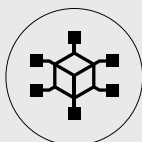

HIGH DISCRIMINATION AND THROUGHPUT

- Total compatibility with previous IP20 (plastic) and IP65 (stainless steel) control units
- Robust structure through the use of high-performance polymers for the construction of housing
- Waterproof / Dustproof: IP66 compliant (IEC 60529)
- Exceptional impact resistance at low and high temperatures and resistance to corrosion from atmospheric agents
- Display made with specific polymer to improve the visibility of the LEDs by increasing the definition and clarity



HIGH DISCRIMINATION AND THROUGHPUT

- High visibility of the control unit and the zone indication independent from the operator position and the installation environment
- Flexible Acoustic Alarm Signaling System:
 - 10 Continuous and Pulsed Tones
 - 34 Special Sounds
- 10 Alarm Volume Levels
- Very High Precision Transit Counter
 - In-Bound, Out-Bound transits
 - Alarm Rate
 - Automatic Compensation for repeated

4 MULTI-ZONE DISPLAY BARS

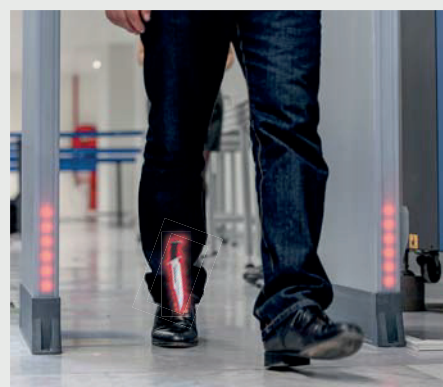

4 Multi-Zone Display Bars, each programmable as entry Stop/Go and/or local alarm indication.

Light bars indicate **metal position vertically and laterally** and can also show **pacing lights**.



RAPID INSTALLATION

- One touch guided automatic installation (OTS)
 - Innovative function assisting the installation through an automatic step-by-step procedure
- Continuous self diagnostics assures monitored performance reliability

CEIA USA reserves the right to make changes, at any moment and without notice, to the models (including programming), their accessories and options, to the prices and conditions of sale.

STANDARD CONFIGURATION

Compliant with the strictest detection and discrimination standards for EMDs (Enhanced Metal Detectors)	●
4 display bars each programmable as zone indicators and/or pacing lights	●
60 localization zones (20 vertical x 3 lateral) with left, center and right indication	●
Antivandalic and Antitampering IP66 control unit	●
High precision transit counter (2-beam)	●
Chip Card Reader	●
BT, infrared and RS-232 communication	●
Programmable Random Alarm capability	●
3-Level Password and hardware key access protection	●
Met-Identity technology (separate Ferrous and Non-Ferrous alarm signaling)	●
One Touch Automatic Self Installation (OTS)	●
Automatic Operational Functional Verification (OFV)	●
Automatic Vibration Compensation (AVS, EVA)	●
Automatic Channel Search (CS)	●
Automatic Floor Gain Adjustment (FGA)	●
Automatic Technical Functional Verification (TFV)	●
Automatic Environmental Noise Compensation (ENA)	●
Powered by safe low voltage DC	●
Anti-tamper on/off switch	●

COMMUNICATION CAPABILITIES

TYPE OF OPERATION	ETHERNET	USB	INFRARED	BT	RS-232
MAINTENANCE	○	○		●	●
REMOTE CONTROL	○		●	●	●
REMOTE DATA	○				

STANDARD ● OPTION ○

CEIA USA reserves the right to make changes, at any moment and without notice, to the models (including programming), their accessories and options, to the prices and conditions of sale.

DIMENSIONS

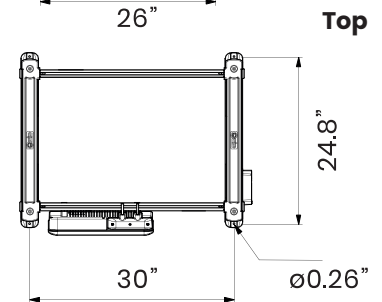
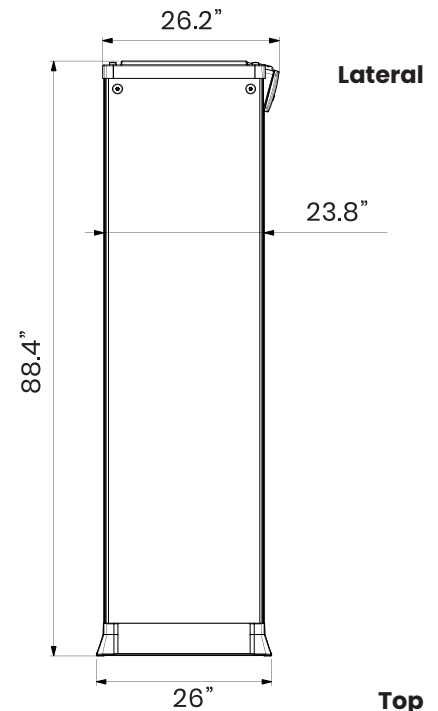
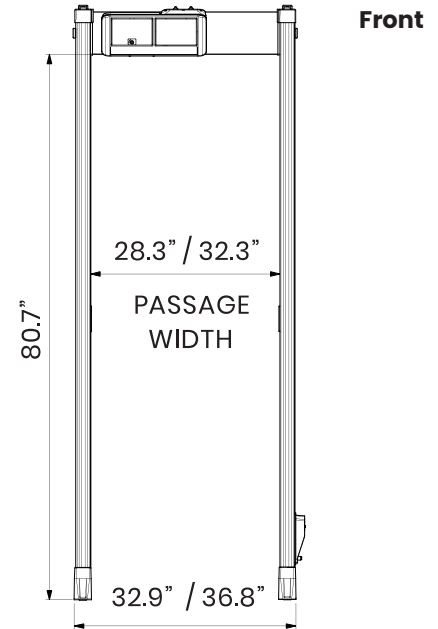

NETID ANYWHERE™

WALK-THROUGH METAL DETECTOR MANAGEMENT SYSTEM

NetID Anywhere is a cloud-based systems management solution for CEIA walk-through metal detectors (WTMD) that centralizes access to important statistics, automates monitoring of critical calibration parameters.



MONITOR

- Monitor WTMD status and settings
- Avoid accidental or unwanted setting changes
- Email notification for critical events or changes
- Logs for every event or change in the WTMDs
- Advanced diagnostics capability

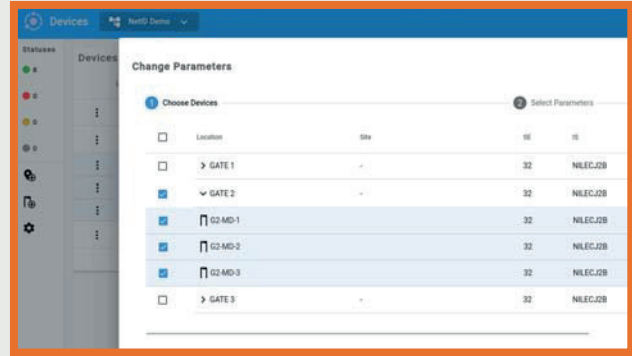

REPORT

Data is collected and retained for each metal detector, including number of transits and metal alarms, allowing analysis of transit flows and alarm rate trends

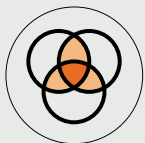

NETWORKING

- No software to install
- No Infrastructure required
- Easy to install and integrate
- Secure
- Scalable
- Easy to Use, Limited Training Required
- Technical support and software updates included

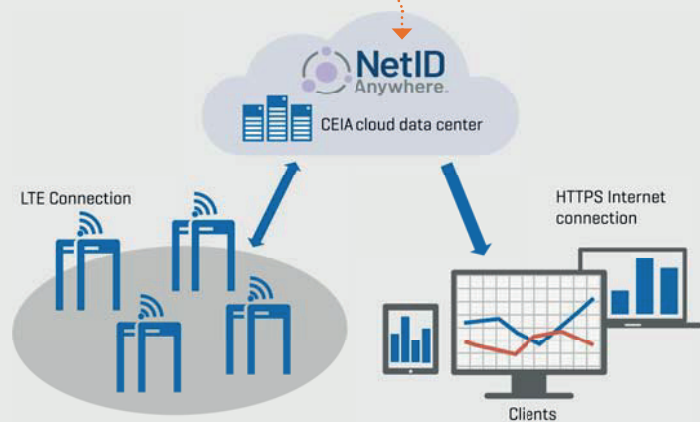

CEIA USA reserves the right to make changes, at any moment and without notice, to the models (including programming), their accessories and options, to the prices and conditions of sale.

OPTIONS

OPTION	DESCRIPTION	CODE
--------	-------------	------

IP65 CONFIGURATION

Outdoor sheltered permanent or non-sheltered short-term installations (single event entrance).
This kit includes shelters, and protection covers for power supply.



- 28.3" passage width (102710)
- 32.3" passage width (102712)

EMBEDDED BATTERY BACK-UP AND CHARGER

Lower Connection Module with anti-tamper on/off switch, RS-232 interface and internal battery back-up.
The module provides an audible "flat battery" signal activated when the battery charge goes below the operational limit of the device (signal endurance: about 12 hours).



APSiM2Plus/P

APSiM2 PLUS Integrated Web-server & Logger, Battery Back-up and Charger

Lower Connection Module with anti-tamper on/off switch, RS-232 interface, internal battery back-up and the following functions:

- Built-in 10/100 base T Ethernet LAN interface
- Web server for set-up and remote data log
- Real/Time clock with battery backup
- Non-volatile Memory for Metal Detector events storage



APSiM2Plus/P



APSiM3 PLUS Wireless Network Module

Includes all features and characteristics of the APSiM2 Plus with additional:

- Wi-Fi communication capability
- Compatibility with NetID Management software (NetID software license not included)











APSiM2Plus/P



32.3" USEFUL PASSAGE WIDTH

55635

ACCESSORIES

ACCESSORY	DESCRIPTION	CODE
CHIP CARDS	Chip cards for simple and secure selection of Security Levels and parameter setting. List of chip-cards available on request.	
MD-WHK	Wireless repeater of acoustic indications for WTMDs.	MD-WHK
CROSSBAR BATTERY BACK-UP	<ol style="list-style-type: none"> 1 Crossbar battery back-up in stainless steel case. Up to 10 h of autonomous working time. 2 Protection cover 	 <p>55681</p> <ul style="list-style-type: none"> • 28.3" passage width: 88858 • 32.3" passage width: 88861
RCU2	Control unit for full remote access, including alarm signalling and programming of CEIA Metal Detectors. The connection is performed via serial cable connection or via BT (option).	 <p>RCU2</p>
MD-SCOPE	<p>Powerful, PC based installation and service Software. Includes oscilloscope and terminal functionality.</p> <p>The connection is performed via BT (standard) or via cable connection.</p>	 <p>MD-SCOPE2</p>
SUPPLY UNIT SERIES	<ol style="list-style-type: none"> 1 MBSU LWSC (Light Weight Soft Case Version) 2 MBSU-2 3 TSU (Tactical supply unit) <p>Portable and compact battery back-up units and charger designed to supply DC voltage to CEIA equipment where mains is not available or as Uninterruptable Power Supply unit (UPS) in installations requiring continuous operations.</p> <p>TYPICAL CONTINUOUS OPERATION</p> <ul style="list-style-type: none"> • MBSU LWSC: 14h • MBSU-2: 14h • TSU: 4 battery pack: 12h / 6 battery pack: 17h / 8 battery pack: 23h 	 <p>MBSU LWSC</p>  <p>MBSU-2</p>  <p>TSU</p>
RRU	Remote relay unit (RRU) to repeat the detection alarms of the gate through a relay contact. The RRU module can be used for integration of the Metal Detector in interlocked door systems. An additional relay is available for a customer-specified application.	RRU-2
IRC-1	Infrared Remote Controller for wireless remote programming of the control unit.	 <p>47180</p>
UPPER CONNECTION MODULE	This module along with an extension cable allows the connection of power supply and serial communication to personal computers or CEIA accessories.	<ul style="list-style-type: none"> • 46650 • 7": 89040 • 16.4 ft: 95352
TOP POWER CABLE	This cable allows the AC/DC adapter to be connected to PS/COM port located on top of the TX antenna to supply the Metal Detector Gate.	 <ul style="list-style-type: none"> • 32.8 ft: 64228 • 65.5 ft: 68346

CEIA USA reserves the right to make changes, at any moment and without notice, to the models (including programming), their accessories and options, to the prices and conditions of sale.

ACCESSORIES

ACCESSORY	DESCRIPTION	CODE
INTEGRATED CAMERA SYSTEM	Chip cards for simple and secure selection of Security Levels and parameter setting. List of chip-cards available on request.	54253
TDU Thermal Detection Unit	The TDU (Thermal Detection Unit) is an upgrade sensing kit for COVID screening compliance: <ol style="list-style-type: none"> 1 Thermal Camera Arm 2 Dual Reference Calibration Unit 	TDU/P
WHEEL KIT - LONG RANGE	For heavy duty, longer range movement of the walk-through metal detector.	70796
WHEEL KIT - SHORT RANGE	For short range movement of the walk-through metal detectors.	75459U
METAL DETECTOR DIVESTING TABLE	In combination with CEIA Walk-Through Metal Detectors, it is a temporary location of personal metal effects for people to be screened: <ol style="list-style-type: none"> 1 Standard length: 24" 2 Extended length: 47" 3 Outdoor version: 51" 	STANDARD: 18074 EXTENDED: 39491 OUTDOOR: 6702IU
TEST SAMPLES KIT	Reference Samples for accurate verification of the Security Level. Includes guided procedures and certificate of calibration	23870 EMD-SK-GAL 64435 EMD-SK-GDML
OFV	Operator Functionality Verification test-kit	OFV-KITCASE

CEIA USA reserves the right to make changes, at any moment and without notice, to the models (including programming), their accessories and options, to the prices and conditions of sale.

SAMPLE INSTALLATIONS



SPECIAL EVENTS

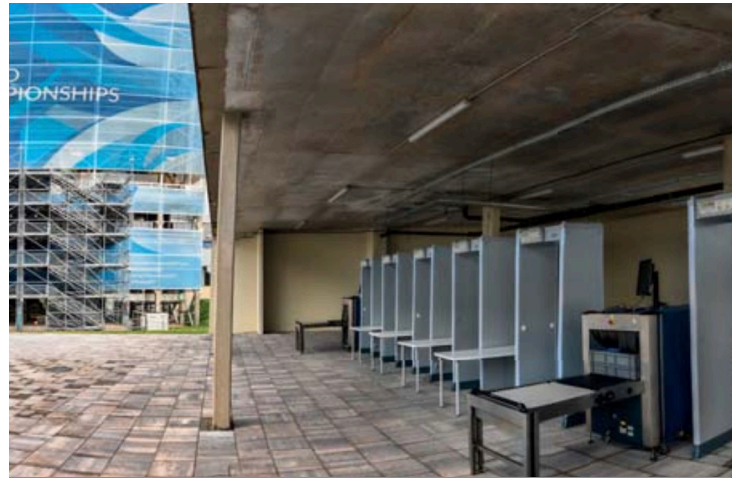

SPECIAL EVENTS



BUILDING SECURITY



AIRPORT SECURITY



AMUSEMENT PARKS



AMUSEMENT PARKS

CEIA USA reserves the right to make changes, at any moment and without notice, to the models (including programming), their accessories and options, to the prices and conditions of sale.

SPECIFICATIONS

GATE STRUCTURE State-of-the-art, robust and washable panels
Protected against aging, weather and wear

OPERATIONAL FEATURES High discrimination and transit flow rates five or more times greater than other metal detection systems
Quick reset time as short as 0.2 seconds for high throughput rate
Very high detection speed (up to 50" ft/sec.)
Built-in operational functional verification
One-touch key reading of inbound, outbound and Security Level Data

QUALITY Continuous self diagnostic system
Proven reliability
No periodic re-calibration and preventive maintenance required
No scheduled maintenance
Fully digital design

ALARM SIGNALING Multi-zone display bar for "height on person" localization
4 light bars with selectable entry/exit and pacing indication
Green and red metering signals proportional to the mass of the detected target
10 selectable continuous and pulsed tone plus 34 special tones
10 selectable sound intensities ranging from 0 to 90 dbA at 3.3 ft

TYPE OF SIGNALING Fixed or proportional to the mass in transit - visible from 19.7 ft under lighting of 4000lux
60 distinct zones (20 vertical x 3 lateral) entry and exit side

PROGRAMMING Up to 50 built-in Security Programs
Remote via Infrared Remote Control Unit, BT or Ethernet 10/100 base T (option) interface
Security level: International Standard (IS) command / Chip card
Local by Control Unit alphanumeric display and keyboard
Programming and chip card access protected by user and super-user passwords

ENVIRONMENTAL DATA Power Supply : 100...277V~ ±10%, 47...63Hz, 40 VA typical consumption
Operating temperature: -4°F to 149°F (-34°F to 158°F upon request)
Storage temperature: -34°F to 158°F
Relative humidity: 0 to 95% (without condensation)

INSTALLATION DATA Automatic synchronization between two or more metal detectors with distance of down to 2" without the use of external cables
Automatic Installation function (OTS)

CERTIFICATION AND COMPLIANCE

- Compliant with and certified to the applicable Standards for Enhanced Metal Detectors (EMD)
- Compliant with the applicable electromagnetic Standards on Human Exposure and Pacemaker Safety
- Compliant with all Airport Security Standards worldwide
- Compliant with applicable International Standards for electrical safety and EMC

APPLICATIONS

- GOVERNMENT BUILDINGS
- AIRPORTS
- INDUSTRIES
- NUCLEAR FACILITIES
- PRISONS (VISITORS)
- PUBLIC EVENTS
- AMUSEMENT PARKS
- COURTS
- DATA PROCESSING CENTERS (EDP)
- HOTELS
- SCHOOLS SECURITY

COMPREHENSIVE SUPPORT

CEIA USA PROVIDES FULL OPERATIONAL AND TECHNICAL TRAINING SUPPORT BY CERTIFIED PERSONNEL EITHER AT CEIA FACILITY OR AT CUSTOMER LOCATION.

CEIA USA reserves the right to make changes, at any moment and without notice, to the models (including programming), their accessories and options, to the prices and conditions of sale.