

## RIZON

### Pegasus Max

#### Portable Outdoor Optical Turnstile

The Pegasus Max Portable Optical Turnstile is an innovative new product in the world of Portable Turnstiles. Built with securing construction sites in mind, The Pegasus Max brings the benefits of Optical Turnstiles to outdoor portable applications. Seamlessly combining Rizon Canopy and Baseplate technology with Outdoor Optical Turnstiles, this product ensures optimal performance and a robust access control solution for your site.

The Pegasus Max is designed to provide ease of installation without compromising efficiency, enabling deployment in a multitude of locations nationwide.

*\*Rizon Pegasus Construction Series Patent Pending\**



### Benefits and Features

- Maximum people per minute.
- 3x the throughput of a traditional full height turnstile.
- Tailgating and piggyback detection and notification.
- Fits in tight spaces, small footprint, great for urban environments.
- ADA and egress compliant - no additional gates required.
- Ideal for workers carrying tools and bags.
- Network controllable and customizable.
- Easy to transport - designed to be lifted with a forklift.
- Lower maintenance than traditional full height turnstiles.
- Gates open automatically if an emergency situation occurs.
- Convenient linking kit for linking multiple units together.
- Quick connection capability for temporary fencing.
- Bi-directional.
- Anti-slip surface at entry and exit points.

Now available through Sunbelt Rentals  
Sunbelt Priority Support  
888-707-2486

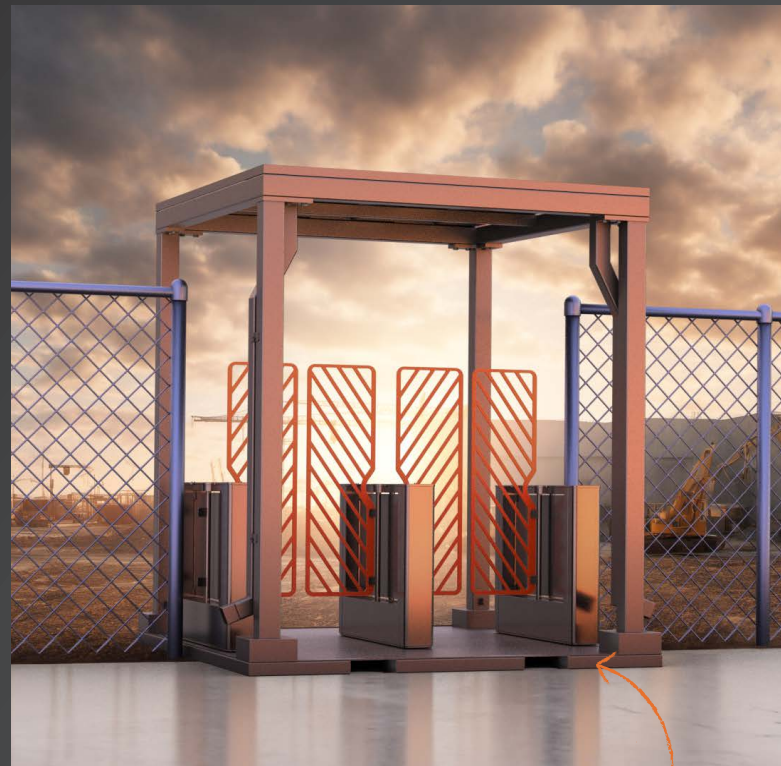

Easy to pick up on all four sides.

**Options**

- Collapsible Ramps
- Module Linking Package
- Alternative card readers available to be implemented upon request

**Operating Modes**

Card in/card out; card in/free exit; free entry/free exit exit only

**Available Finishes**

IP 44 Water Resistance Rating, Stainless Steel with Anti-Slip walkway

**Common Applications**

- Construction Site Perimeter Security
- Perimeter control/fence line security
- Time and attendance integration
- Loss prevention
- Employee and visitor access control
- Unmanned point of entry
- Traffic control

**Typical Installation Sites**

- Construction Sites
- Event Entrances
- Convention Centers
- Stadiums and Arenas
- Parking Lots
- Temporary Security Zones

**Electrical**

Power Consumption: At rest 40W, In Operation 85W, Maximum 150W

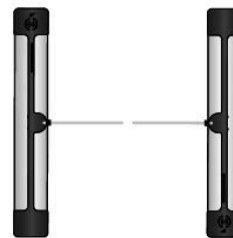
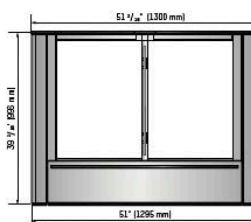
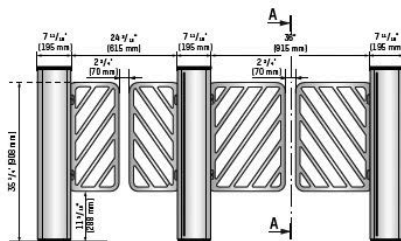
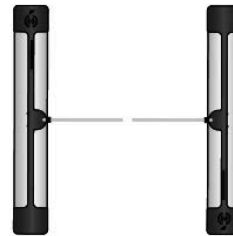
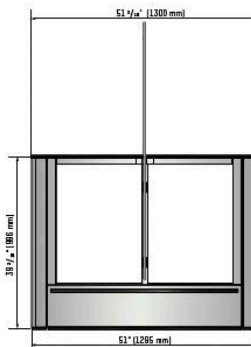
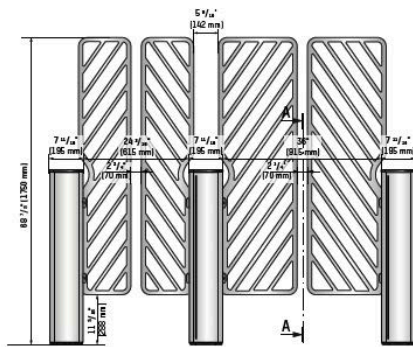

FIRSTLANE PLUS - LOW

